

SLR	
Type	Load Rating <b>C [daN]</b>
SLR-480	20
<b>Other dimensions on request!</b>	

Skate Wheel: Steel

**SLR-**

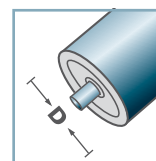

**D [mm]**

-

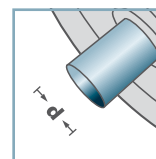

**d [mm]**

6; 8

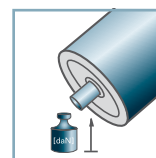

**C [daN]**

20

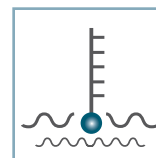

**T [°C]**

-



-



**Carton [pcs.]**

250



# KLR/SLR/SR

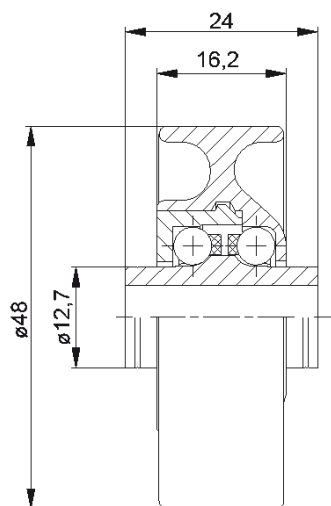

**KLR-02/03**

Type	Normal .02	Stainless .03	Load Rating C [daN]
KLR-480	x	x	10

**Other dimensions on request!**

- ☛ Housing: Plastic
- ☛ Inner Race: Plastic
- ☛ Bearing Cap: Plastic
- ☛ Ball Cage: Plastic
- ☛ Ball
  - ☛ 02: Steel
  - ☛ 03: 1.4034



**KLR-02  
KLR-03**

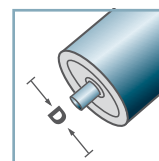

**D** [mm]

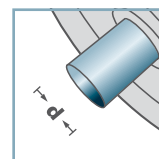

**d** [mm]  
6; 8

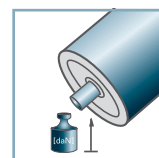

**C** [daN]  
10

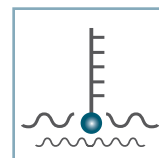

**T** [°C]  
0° - 80°



**Carton** [pcs.]

250

**KLR/SLR/SR**

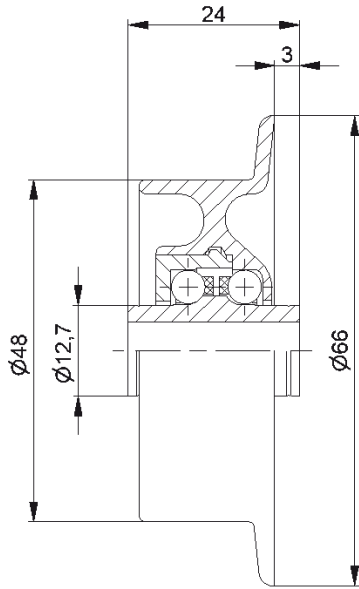

SR-02/03			
Type	Normal .02	Stainless .03	Load Rating C [daN]
SR-480	x	x	10

**Other dimensions on request!**

- ☛ Housing: Plastic
- ☛ Inner Race: Plastic
- ☛ Bearing Cap: Plastic
- ☛ Ball Cage: Plastic
- ☛ Ball
  - ☛ 02: Steel
  - ☛ 03: 1.4034



SR-02  
SR-03

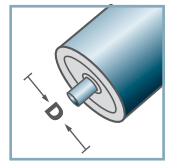

D [mm]

-

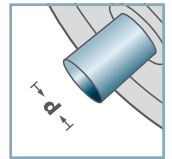

d [mm]  
6; 8



C [daN]  
10

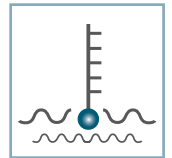

T [°C]  
0° - 80°



-



Carton [pcs.]

250

KLR/SLR/SR

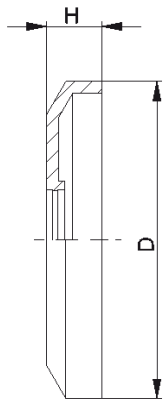

DK-KLR		
Type	D	H
DK-KLR-02	40,5	7
<b>Other dimensions on request!</b>		

🔩 Seal Bonnet: Plastic



**DK-KLR-02**

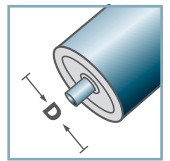

**D** [mm]

-

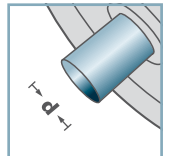

**d** [mm]

-



**C** [daN]

-

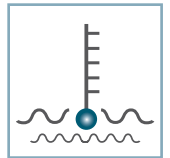

**T** [°C]

0° - 80°



-



**Carton** [pcs.]

-

**KLR/SLR/SR**