

V-Beltdrive PJ VR-

Type	Di	Da	Load Rating C [daN]
50x1,5.40	47,3	49,8	80

Driving belt available on request!

- ☛ Housing: Plastic
- ☛ Single Labyrinth Seal: Plastic
- ☛ Bearing 6202
also with two bearings available

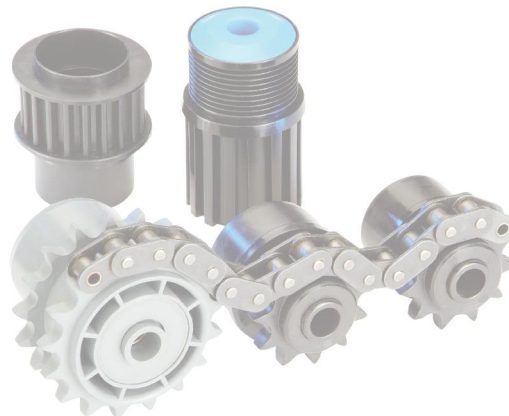

VR-40

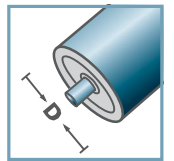

D [mm]
50

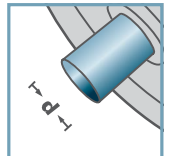

d [mm]
12; SW11



C [daN]
-

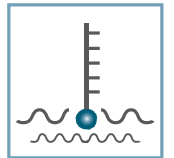

T [°C]
0° - 80°



EP 2



Carton [pcs.]

100

Plastic VR-Belt Drive

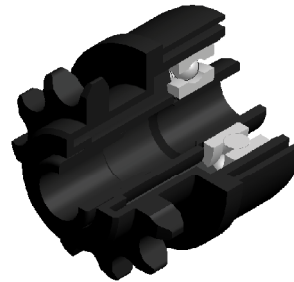
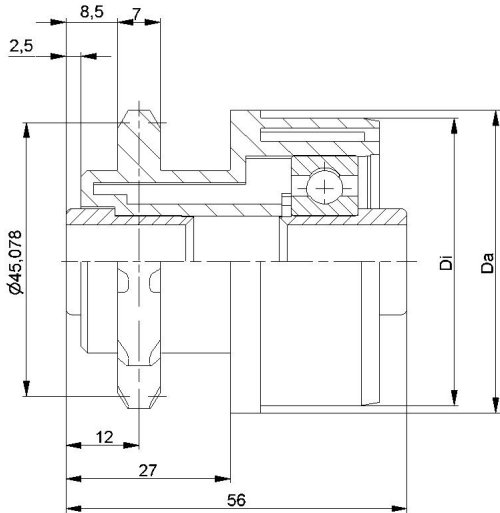

KKR-1/2" x5/16" -Z11 for fix driving

Type	Di +0,2	Da
50x1,5.40	47,3	49,9
50x2,8.40	44,6	49,9

Other dimensions on request!

- ☛ Housing: Plastic
- ☛ Reducing Bush: Plastic
- ☛ Bearing 6202

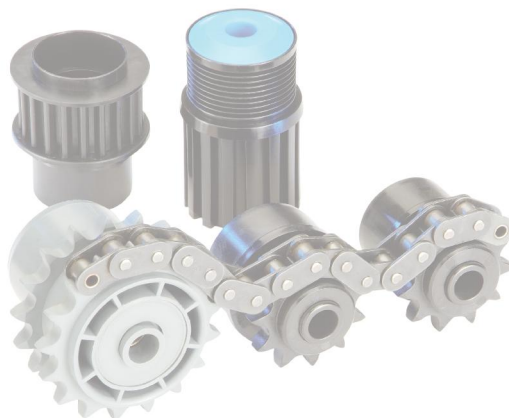

KKR-40

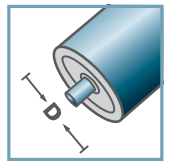

D [mm]
50

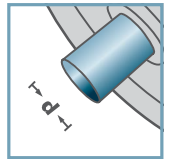

d [mm]
12



C [daN]
-

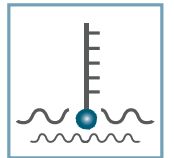

T [°C]
0° - 80°



EP 2



Carton [pcs.]

150

Plastic Sprocket Wheel

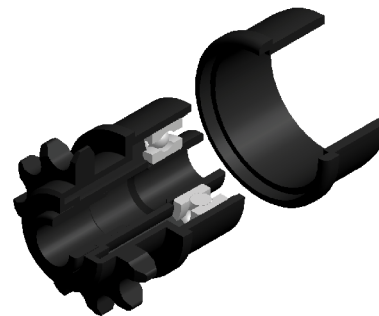
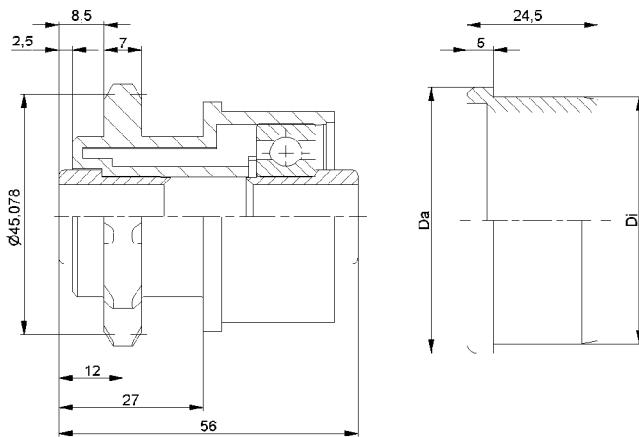

KKR-1/2" x5/16" -Z11 for friction driving

Type	Di +0,2	Da
50x1,5.40 ST	47,3	49,9

Other dimensions on request!

- ☛ Housing: Plastic
- ☛ Reducing Bush: Plastic
- ☛ Sliding Ring: Plastic
- ☛ Bearing 6202

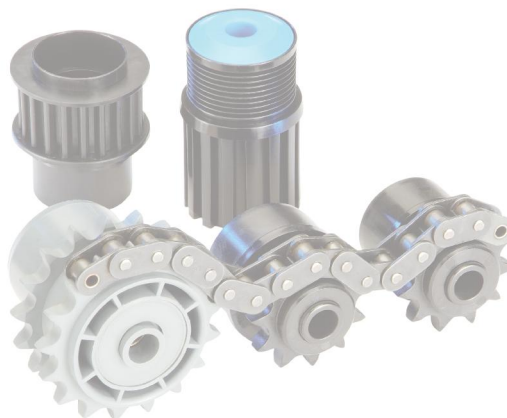

KKR-40

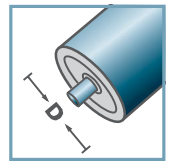

D [mm]
50

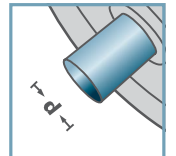

d [mm]
12



C [daN]
-

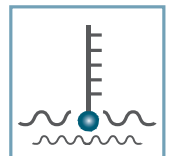

T [°C]
0° - 80°



EP 2



Carton [pcs.]

Housing:
150
Sliding Ring:
300

Plastic Sprocket Wheel

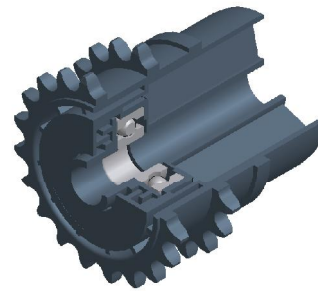
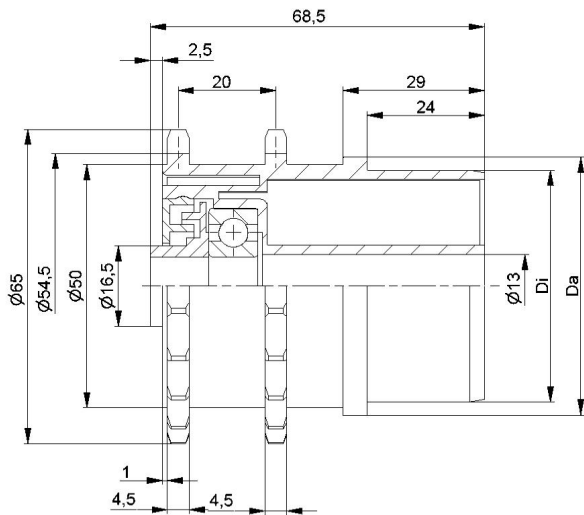

KKR-3/8" x3/16" -Z20		
Type	Di +0,2	Da
53x3,0.41	47,6	52,9

Other dimensions on request!

- ☛ Housing: Plastic
- ☛ Inner Labyrinth Seal: Plastic
- ☛ Outer Labyrinth Seal: Plastic
- ☛ Bearing 6201

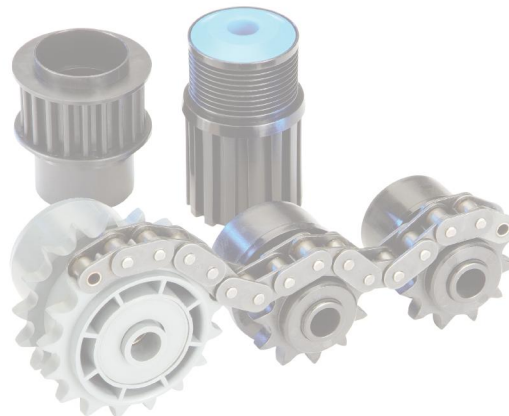

KKR-41

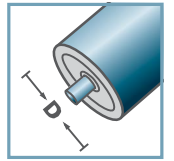

D [mm]
53

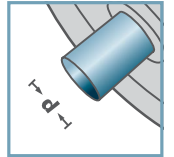

d [mm]
12



C [daN]
-

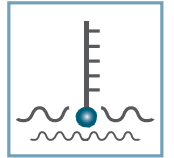

T [°C]
0° - 80°



EP 2



Carton [pcs.]

60

Plastic Sprocket Wheel

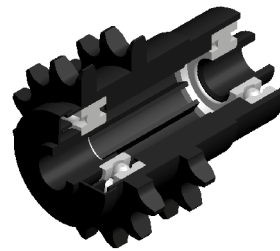
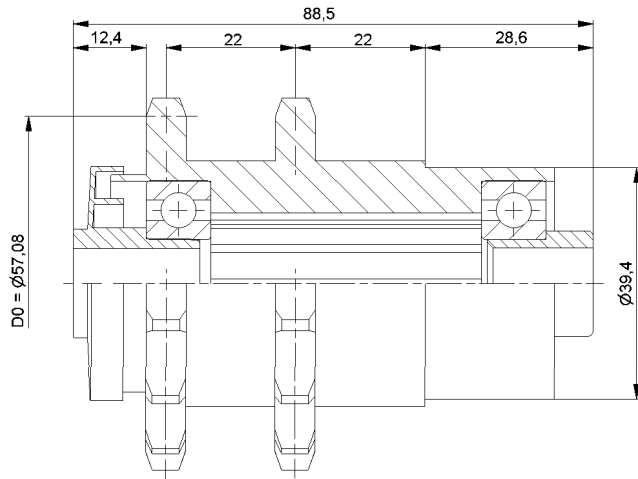

KKR-1/2" x5/16" -Z14

Other dimensions on request!

- ☛ Housing: Plastic
- ☛ Labyrinth Seal: Plastic
- ☛ Reducing Bush: Plastic
- ☛ Bearing 6202

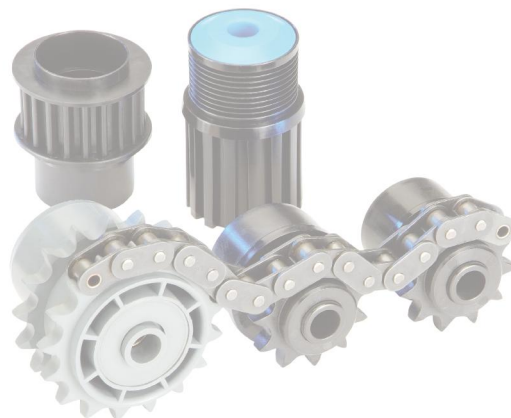

KKR-40

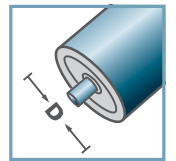

D [mm]

-

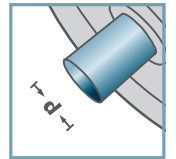

d [mm]
12



C [daN]

-

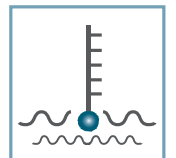

T [°C]
0° - 80°



-



Carton [pcs.]

150

Plastic Sprocket Wheel

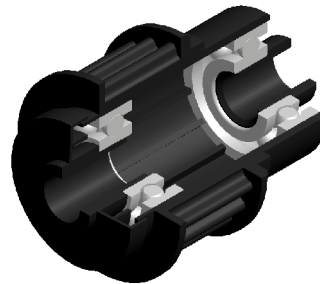
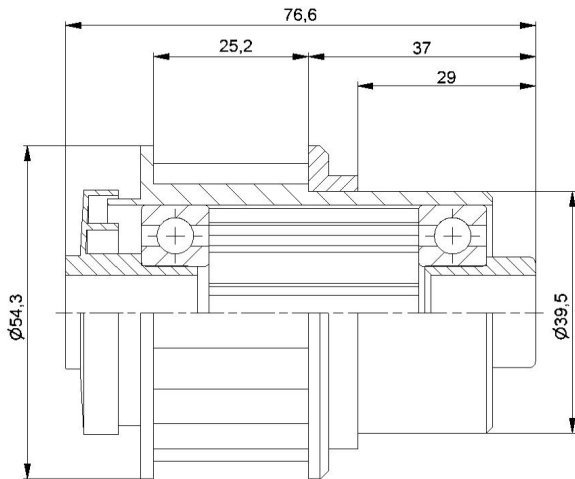

KZA-Z20.40	
Other dimensions on request!	

- ☛ Housing: Plastic
- ☛ Labyrinth Seal: Plastic
- ☛ Reducing Bush: Plastic
- ☛ Bearing 6202

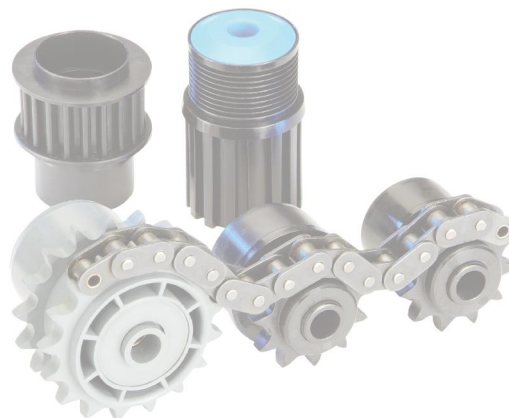

KZA-40

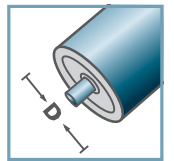

D [mm]

-

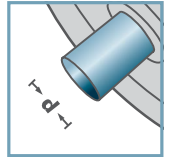

d [mm]

12



C [daN]

-

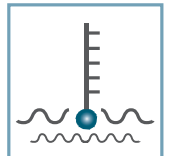

T [°C]

0° - 80°



-



Carton [pcs.]

100

Plastic Synchronous Belt Drive